

VENTILADOR CENTRÍFUGO BAJA PRESIÓN Serie CBM (EXTERNAL ROTOR)



DESCRIPCIÓN:

Ventiladores centrífugos de baja presión fabricados en chapa de acero galvanizado protegida con pintura poliéster anticorrosiva, rodete de álabes hacia adelante, conjunto motor-rodete equilibrado dinámicamente, motor IP44, Clase B, con rodamientos y protector térmico de rearme automático.

MOTORES

De rotor exterior con muy buena regulación. De 2, 4 o 6 polos según versiones. Tensión de alimentación monofásicos 230 V - 50 Hz

OTROS DATOS

Bajo pedido, modelos con brida de acoplamiento montada a la salida del ventilador.



Configuración simple aspiración



Gran compacidad

El especial diseño del conjunto motor-rodete proporciona gran compacidad, especialmente en los modelos de simple oído



Rodete equilibrado dinámicamente

Según norma ISO 1940, para reducir el ruido y evitar vibraciones.



Configuración doble aspiración

Características técnicas

Es imprescindible comprobar que las características eléctricas (voltaje, intensidad, frecuencia, etc.) del motor que aparecen en la placa del mismo son compatibles con las de la instalación.

Modelo	Potencia motor (W)	Velocidad (r.p.m.)	Conensador (µF/V)	Intensidad máxima absorbida (A)	Caudal máximo (m³/h)	Temperatura máxima aire (°C)	Nivel de presión sonora* (dB(A))	Peso (kg)	Regulador de tensión opcional	
									REB	RMB
SIMPLE OIDO DE 2 POLOS										
CBM/2-133/046 - 90W	90	2100	2/400	0,4	260	-15/+70	58	1,8	1	1,5
CBM/2-133/062 - 100W	100	1650	2/400	0,4	290	-15/+40	55	1,9	1	1,5
CBM/2-140/059 - 100W	100	1350	2/400	0,5	390	-15/+40	48	2,6	1	1,5
CBM/2-140/059 - 155W	155	2300	5/400	0,7	510	-15/+70	60	3,4	1	1,5
CBM/2-160/062 - 260W	260	2100	6/400	1,1	630	-15/+40	62	4	2,5	1,5
SIMPLE OIDO DE 4 POLOS										
CBM/4-160/062 - 70W	70	1320	2/400	0,3	450	-15/+60	55	3	1	1,5
CBM/4-180/075 - 115W	115	1330	3/400	0,6	650	-15/+55	59	3,5	1	1,5
CBM/4-180/092 - 160W	160	1275	6/400	0,8	970	-15/+40	57	6,5	1	1,5
DOBLE OIDO DE 2 POLOS										
CBM/2-133/190 - 185W	185	1750	5/400	0,8	630	-15/+45	57	3,5	1	1,5
DOBLE OIDO DE 4 POLOS										
CBM/4-133/190 - 70W	70	1150	2/400	0,3	640	-15/+65	47	2,8	1	1,5
CBM/4-160/150 - 125W	125	1150	3/400	0,6	800	-15/+65	54	3,7	1	1,5
CBM/4-180/184 - 150W	150	1250	5/400	1,1	1.330	-15/+60	57	5	2,5	1,5
DOBLE OIDO DE 6 POLOS										
CBM/6-180/184 - 95W	95	850	2/400	0,5	970	-15/+40	48	5	1	1,5

* Nivel de presión sonora a descarga libre, medido en aspiración a 1,5 m en campo libre.

Características acústicas

Los niveles sonoros dados en la tabla de las características técnicas y las curvas son niveles de presión a la aspiración, la tabla siguiente en potencia (LwA), en el tubo a la descarga y aspiración, (Potencia sonora LwA por banda de frecuencia (Hz)).

Modelo		63	125	250	500	1000	2000	4000	8000	LwA
CBM/2-133/046 - 90W	PB	48	53	57	64	69	66	63	60	73
	PM	46	53	60	65	66	64	60	57	71
	PA	45	48	58	65	65	64	59	55	70
CBM/2-133/062 - 100W	PB	42	48	55	61	66	63	60	55	70
	PM	43	51	60	65	64	61	58	53	69
	PA	42	45	55	64	64	61	57	52	69
CBM/2-140/059 - 100W	PB	40	48	53	56	56	55	56	51	63
	PM	38	47	54	58	56	54	53	46	63
	PA	39	48	54	57	56	54	52	47	62
CBM/2-140/059 - 155W	PB	51	61	67	67	67	67	66	61	74
	PM	46	60	66	66	64	65	63	58	72
	PA	47	56	62	64	63	62	61	56	70
CBM/2-160/062 - 260W	PB	46	57	67	70	72	69	67	62	77
	PM	46	56	65	69	72	68	66	61	76
	PA	41	53	61	65	69	67	64	59	73
CBM/4-160/062 - 70W	PB	41	54	57	63	66	59	57	52	69
	PM	38	51	56	60	61	55	53	46	65
	PA	38	51	55	57	57	51	47	39	62
CBM/4-180/075 - 115W	PB	50	58	64	67	68	66	62	58	73
	PM	52	60	65	67	68	65	61	57	73
	PA	53	60	65	68	70	65	62	58	74
CBM/4-180/092 - 160W	PB	46	55	63	65	66	64	60	55	71
	PM	41	51	60	61	61	60	56	50	67
	PA	43	49	57	57	57	56	51	44	63
CBM/2-133/190 - 185W	PB	45	50	58	62	68	64	61	57	71
	PM	55	53	58	65	68	65	61	56	72
	PA	73	62	66	66	65	64	59	53	76
CBM/4-133/190 - 70W	PB	39	46	51	56	57	54	51	45	62
	PM	37	45	51	53	55	50	46	38	59
	PA	38	47	52	53	54	47	42	34	59
CBM/4-160/150 - 125W	PB	36	45	53	61	66	61	58	52	69
	PM	37	44	54	59	63	57	54	46	66
	PA	37	48	56	57	60	54	49	40	64
CBM/4-180/184 - 150W	PB	41	50	56	62	69	65	62	57	72
	PM	40	48	55	59	66	61	58	52	69
	PA	43	50	54	58	63	58	54	46	66
CBM/6-180/184 - 95W	PB	34	42	49	56	58	55	51	46	62
	PM	31	40	48	52	55	51	46	37	59
	PA	35	41	49	50	52	46	39	31	56

Dimensiones (mm)

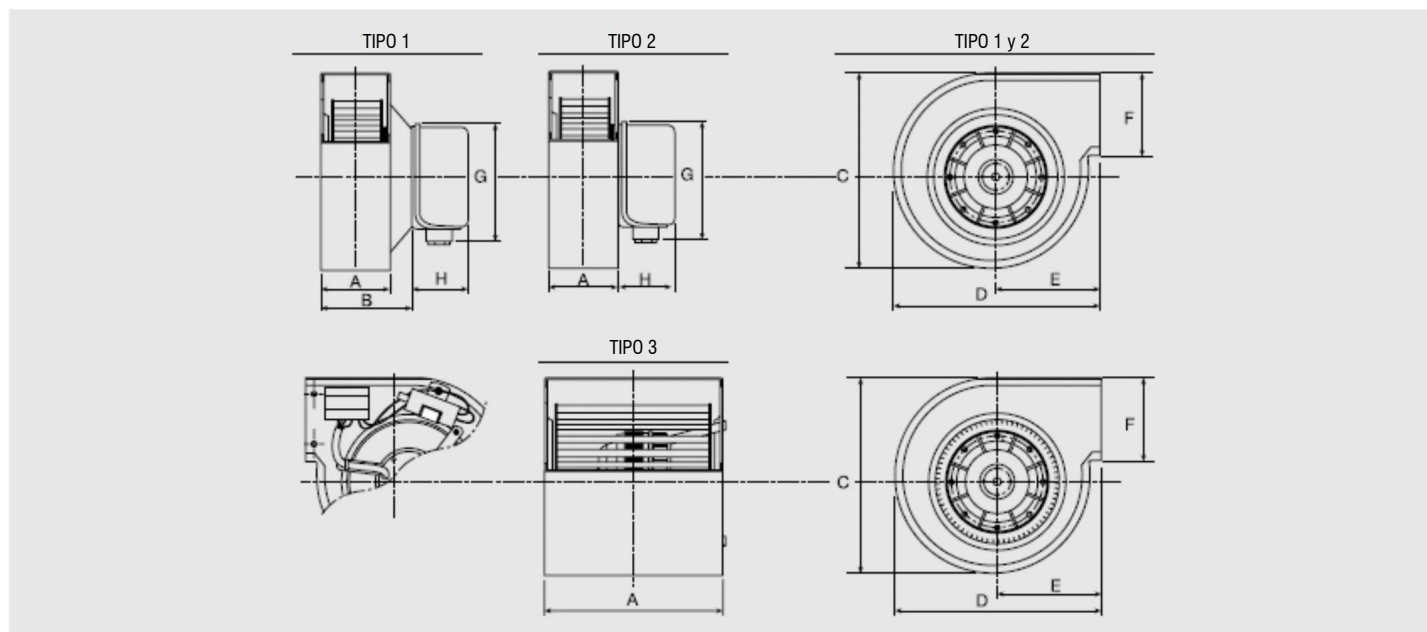

Modelo	Esquema	A	B	C	D	E	F	G	H
CBM/2-133/046	TIPO 1	61	80	181	175	88	69	100	49
CBM/2-133/062	TIPO 1	78	99	181	175	88	69	100	49
CBM/2-140/059	TIPO 2	98	-	244	224	103	94	100	49
CBM/2-160/062	TIPO 2	98	-	244	224	103	94	100	49
CBM/4-180/075	TIPO 2	110	-	260	265	145	122	100	49
CBM/4-180/092	TIPO 2	133	-	332	296	133	136	100	49
CBM/2-133/190	TIPO 3	215	-	183	178	90	70	-	30*
CBM/2-146/180	TIPO 3	224	-	217	203	95	102	-	30*
CBM/4-133/190	TIPO 3	224	-	205	200	102	100	-	30*
CBM/4-160/150	TIPO 3	176	-	240	224	114	105	-	30*
CBM/4-180/184	TIPO 3	224	-	262	270	143	123	-	30*
CBM/6-180/184	TIPO 3	224	-	262	270	143	123	-	30*

* Espesor caja de bornes y condensador en el lateral.

Curvas características

- q_v : Caudal en m³/h y m³/s.
- p_{st} : Presión estática en Pa y mmcd.a.
- SFP: Factor específico de potencia en Wm³/s.
- I: Intensidad absorbida en A.
- Lw: Potencia sonora, en la aspiración, en dB(A).
- Categoría de eficiencia: total.
- Eficiencia del ventilador sin mando de regulación de velocidad.
- Caudal de acuerdo a la Norma ISO 5801

MC	Categoría de medición
EC	Categoría de eficiencia
VSD	Mando de regulación de velocidad: Debe suministrarse con el ventilador
SR	Relación específica
η[%]	Eficiencia
N	Grado de eficiencia
[kW]	Potencia absorbida
[m³/h]	Caudal
[Pa]	Presión estática
[RPM]	Velocidad

CURVA EJEMPLO

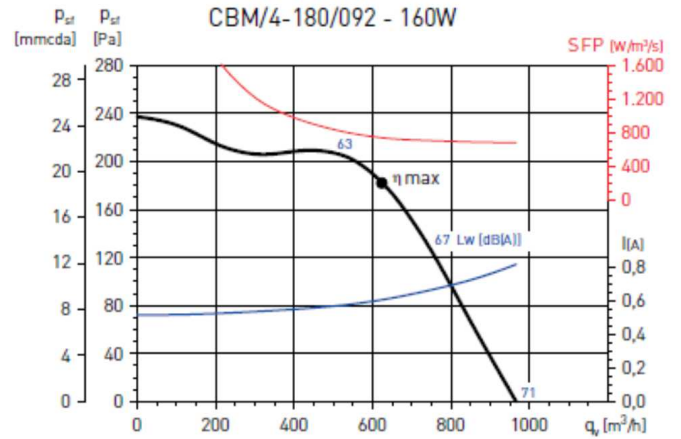

MC*	EC*	VSD*	SR*	η [%]*	N*	[kW]	[m ³ /h]	[Pa]	[RPM]
B	Total	No	1,003	32,3	44,3	0,128	623	238	1408

* Ver curva ejemplo.

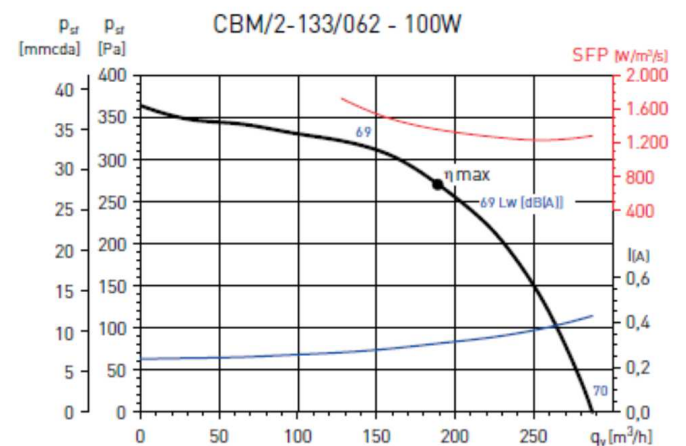
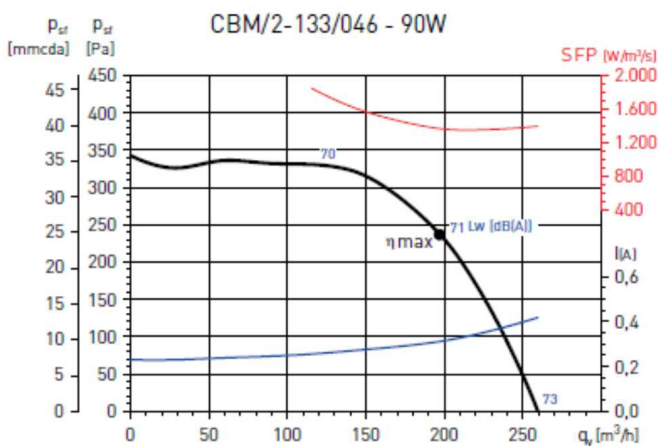

CURVAS CARACTERÍSTICAS

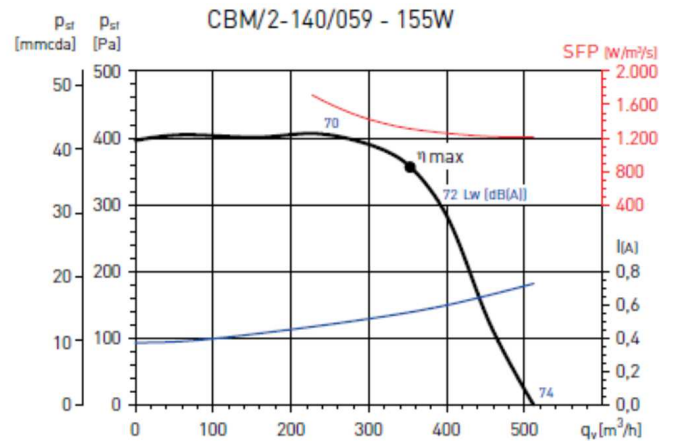
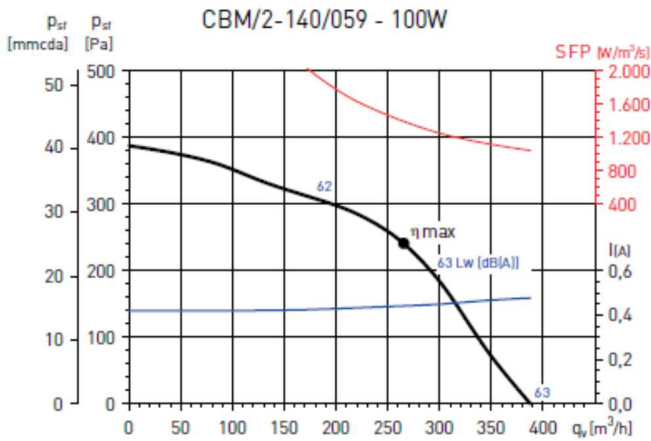

MC*	EC*	VSD*	SR*	η[%]*	N*	[kW]	[m³/h]	[Pa]	[RPM]
B	Total	No	1,005	32,7	44,6	0,129	354	428	2607

* Ver curva ejemplo.

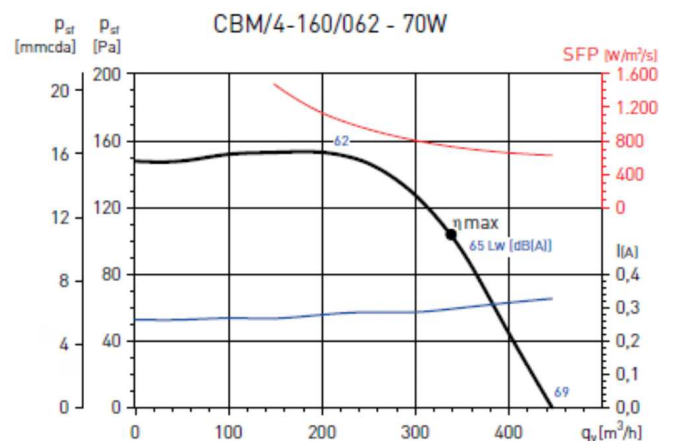
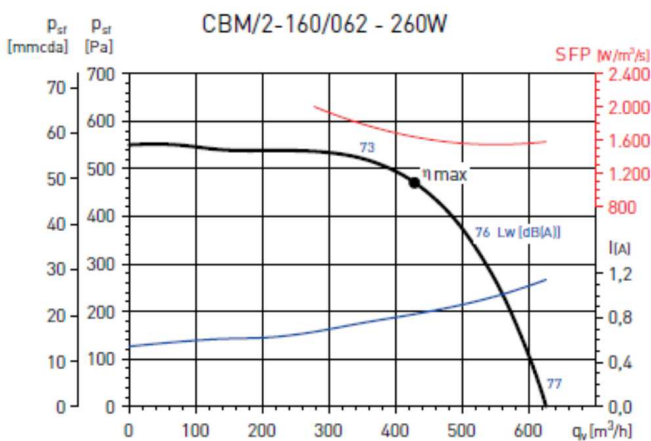

MC*	EC*	VSD*	SR*	η[%]*	N*	[kW]	[m³/h]	[Pa]	[RPM]
B	Total	No	1,006	34,8	45,6	0,196	429	572	2603

* Ver curva ejemplo.

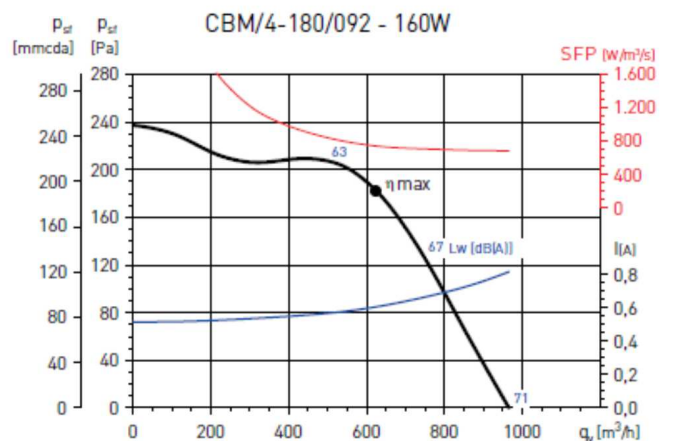
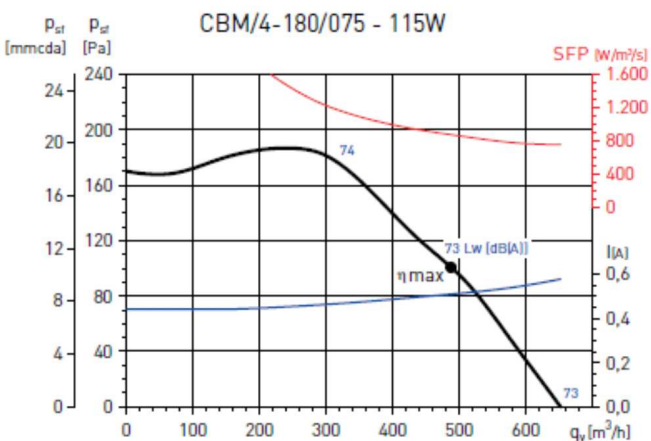

MC*	EC*	VSD*	SR*	η[%]*	N*	[kW]	[m³/h]	[Pa]	[RPM]
B	Total	No	1,003	32,3	44,3	0,128	623	238	1408

* Ver curva ejemplo.

CURVAS CARACTERÍSTICAS

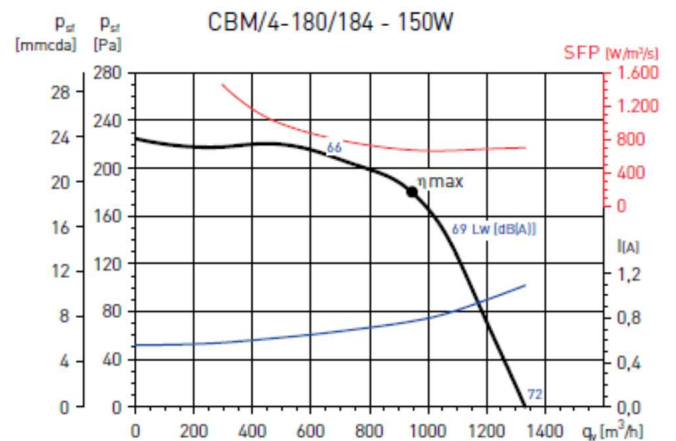
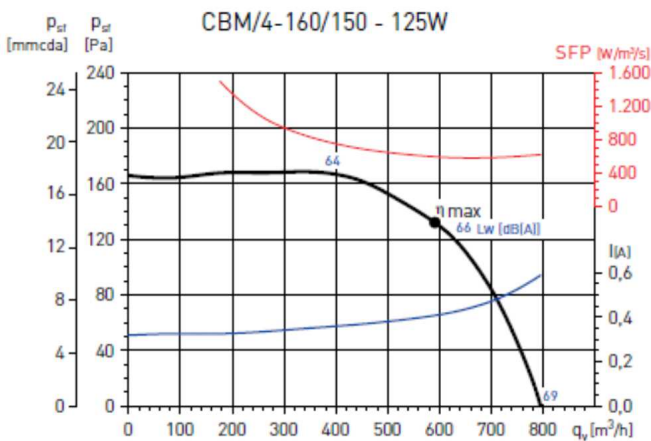
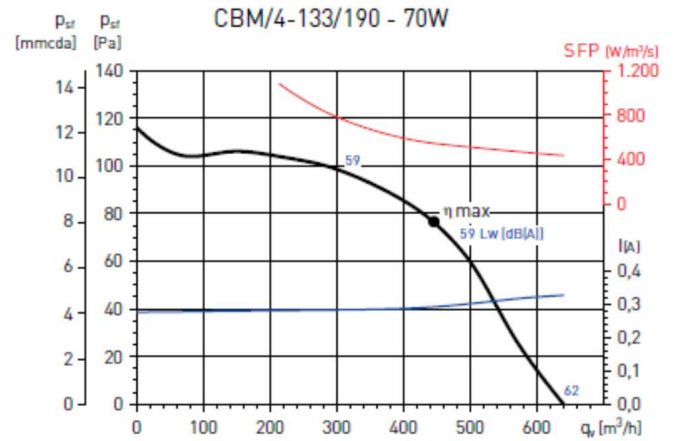
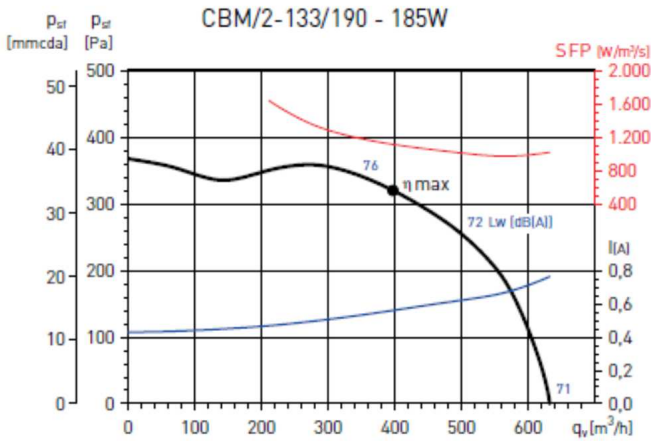

MC*	EC*	VSD*	SR*	η [%]*	N*	[kW]	[m³/h]	[Pa]	[RPM]
B	Total	No	1,003	35,2	46,3	0,177	948	237	1357

* Ver curva ejemplo.

