

**07 VÁLVULA DE ESFERA SOLAR  
Mod. 840**

**ROSCAS ESTÁNDAR:**

- BSP
- NPT



Código:  
SO 07 143-148

**MATERIALES:**

- 1- Cuerpo: EN 12164:1998 CW617N
- 2- Bola: EN12164:1998 CW614N
- 3- Junta: PTFE
- 4- Unión: EN 12164: 1998 CW617N
- 5- Anillo interno: NBR
- 6- Vastago: EN12164:1998 CW614N
- 7- Tornillo: Acero
- 8- Maneta: Aluminio

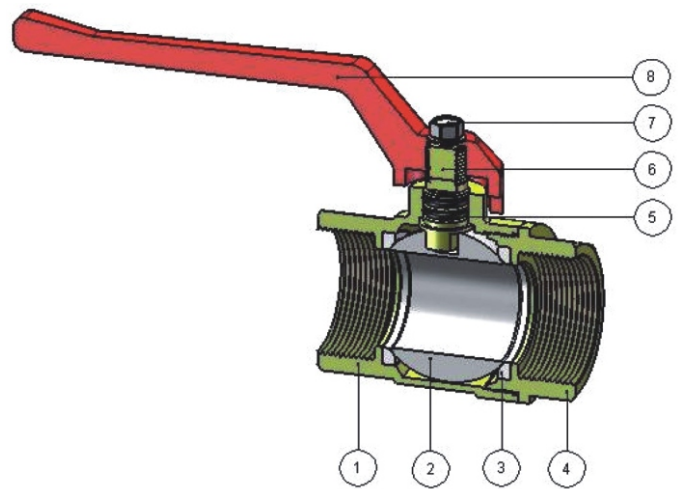

**DIMENSIONES:**

CÓDIGO	MODELO	A	B	C	D	E	F	Ch.
SO 07 143	2"	102	16	2"	50	140	89	67
SO 07 144	1"-1/2	89	16	1"-1/2	40	140	81	54
SO 07 145	1"-1/4	77	15	1"-1/4	32	110	66	47
SO 07 146	1"	66	14	1"	25	110	61	38
SO 07 147	3/4"	57	12	3/4"	20	75	47	31
SO 07 148	1/2"	46	10	1/2"	15	75	44	25

**DIAGRAMA DE PRESIÓN Y TEMPERATURA:**

